

## QK117G

Vaso back to wall con sistema goclean® scarico S/P  
[completo di connessioni di scarico art. LK1012]

Complementi:

- Coprivaso avvolgente in termoindurente (QKCW02)
- Coprivaso avvolgente in termoindurente a discesa rallentata (QKCW03)
- Coprivaso SLIM in termoindurente (QKCW04)
- Coprivaso SLIM in termoindurente a discesa rallentata (QKCW05)
- Coprivaso elettronico multifunzione gocare (FL7235 - FL7035R)
- Cassetta monoblocco Niagara (TR38)
- Accessori linea TWO - HOOP - NOKÈ - FOLD

Accessori tecnici: Kit di fissaggio a pavimento (9003)

Dim. Imballo | Peso **24 kg** | Pz. Pallet n° **18**

UNI EN 997 Dop-No997



**FLAMINIA sconsiglia l'abbinamento di questo Wc con passo rapido/flussometro e cassette alte tradizionali.**

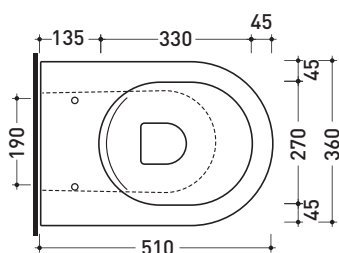

vista zenitale / zenital view

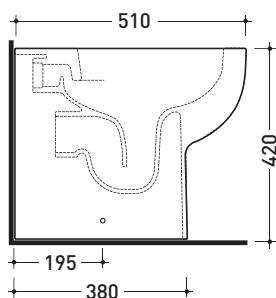

vista laterale / lateral view

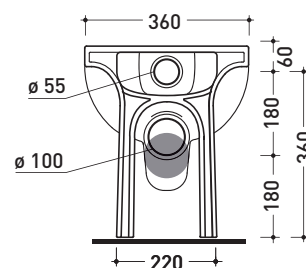

vista retro / back view

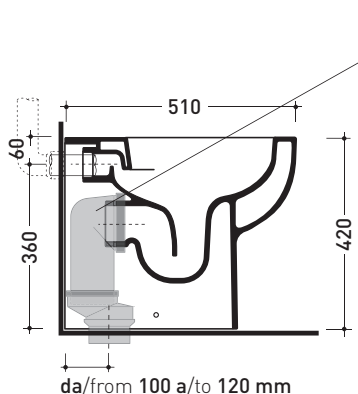

da/from 100 a/to 120 mm

sezione longitudinale / section

art. LK1012  
connessioni di scarico  
(in dotazione)  
drainage connector  
(included in the box)

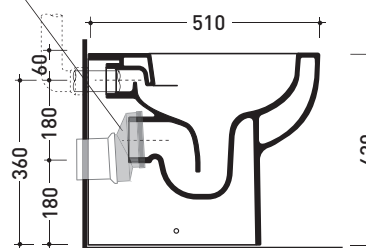

sezione longitudinale / section

dimensioni in mm

Le misure dimensionali riportate hanno una tolleranza del 2%

CERAMICA: finiture lucide



bianco nero

finiture opache



latte grafite antracite grigio lava

## QK217

### Bidet back to wall monoforo

• CON TROPPOPIENO

Complementi: **Complemento bidet Niagara (TR40)**  
**Rubinetti bidet linea ONE - NOKÉ - SI - FOLD - X1**  
**Accessori linea TWO - HOOP - NOKÉ - FOLD**

Accessori tecnici: **Kit di fissaggio a pavimento (9003)**  
**Sifone ribassato cromo (SIFB/CR)**  
**Piletta Stop & Go (PLSG)**  
**Piletta Stop & Go in ceramica (PLCE)**  
**Set 2 pezzi rubinetto filtro cromo (RF026)**

Dim. Imballo | Peso **21 kg** | Pz. Pallet n° **18**

CE UNI EN 14528 - CL20 Dop-No14528

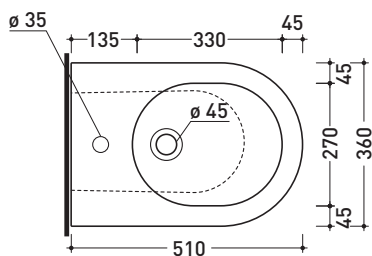

vista zenitale / zenital view

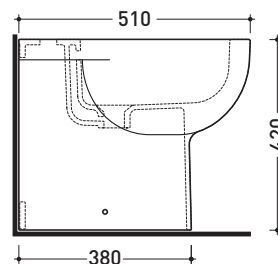

vista laterale / lateral view

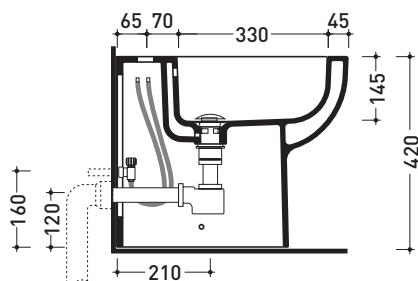

sezione longitudinale / section

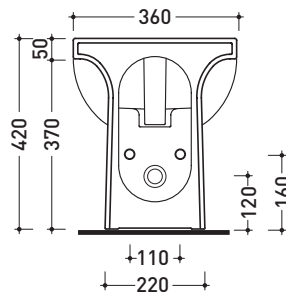

vista retro / back view

dimensioni in mm

Le misure dimensionali riportate hanno una tolleranza del 2%

CERAMICA: finiture lucide



bianco nero

finiture opache



latte grafite antracite grigio lava